

适

灵活适用不同场所

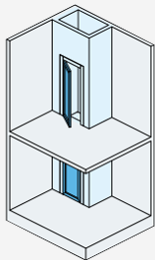

混凝土井道

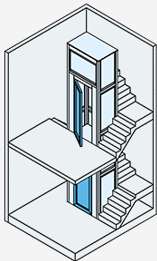

楼梯环绕型

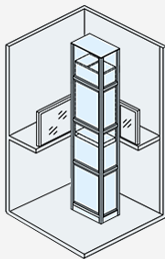

中空大厅型

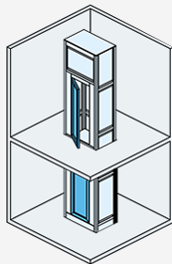

楼层穿越型

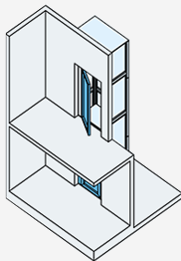

单侧依靠型

■ 独栋-联排-自建; **全场景适用**

适

土建灵活设计

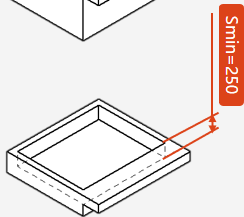
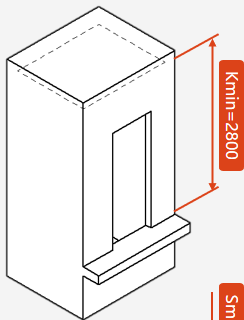

CH=2200—一体顶

传承经典设计

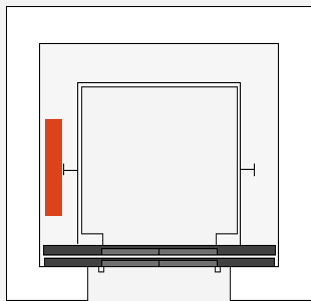

对重侧置

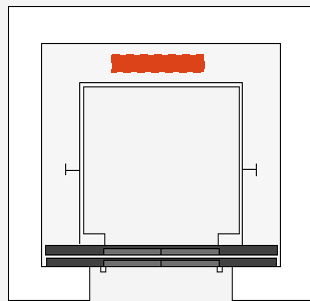

对重位置

对重后置

载重 $\leq 400\text{KG}$, 速度 $\leq 0.4\text{m/s}$

适

灵活匹配建筑与装修



Smart-lego

家用梯井道

喷涂工艺



RAL多色可选

多色玻璃



超白透明



茶色透明

简洁 / 高雅 / 易安装

可替代传统钢结构/定制外观与家居装修完美匹配



静音舒适设计

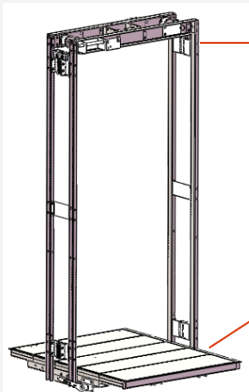

二代**专用减震**
轿架系统



二代**免润滑导靴**



橡胶减震

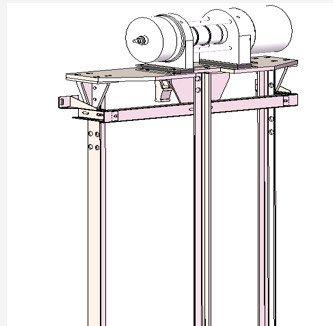

全实心导轨安装



简之有道



多色可选 经典百搭



厚度60mm

厚度相当于一台电脑一体机



低耗电

单次运行能耗：0.02度
(以钢带梯为例，R=12m)

耗电量约等于一台600L一级能耗的冰箱



静音设计

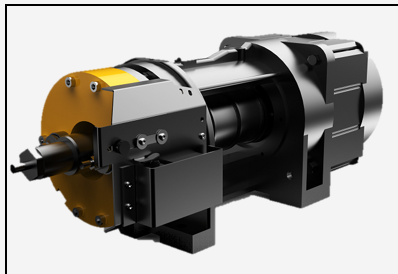

全新一代主机
最新主机制动器噪音抑制方案，更静更舒心

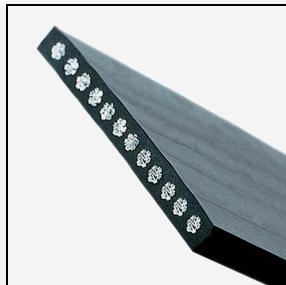

聚氨酯包层增加柔韧性，减小磨损达到免润滑更稳定，更静音

噪音 < 45db

(参考：主机空载噪音(国标 $\leq 62\text{dB(A)}$)制动器噪音(国标 $\leq 70\text{dB(A)}$))



减而不简

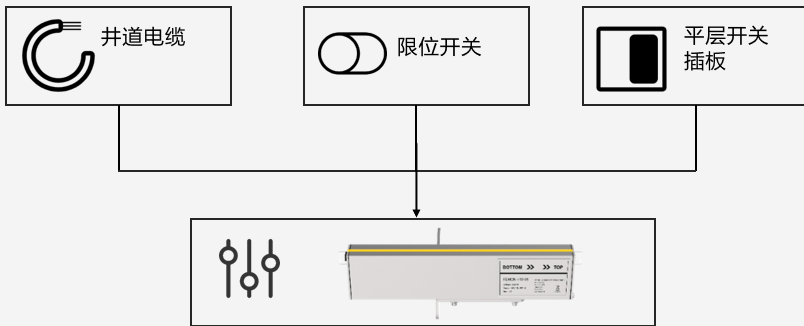

■ 功能高度集成**绝对位置系统**